

# COBRA

MODELS: M41C (DYM1651PF)

## COBRA LAWN MOWER OWNER'S MANUAL



**Cobra Garden Machinery**  
Henton and Chattell Ltd., London Road, Nottingham NG2 3HW UK  
[www.cobragarden.co.uk](http://www.cobragarden.co.uk)

**⚠ WARNING :**

For your own safety please read this manual before attempting to operate your new unit. Failure to follow instructions can result in serious personal injury. Spend a few moments to familiarise yourself with your mower before each use. Keep this manual in a safe place, so that the information is available at all times. If you give the equipment to any other person, hand over these operating instructions and safety regulations as well.

**Intended use:**

The equipment may only be used for the tasks it is designed to handle. Any other use is deemed to be a case of misuse. The user/operator and not the manufacturer will be liable for any damage or injuries of any kind caused as a result of this.

The petrol lawn mower is intended for private use i.e. for use in home and gardening environments. Private use of the lawn mower refers an annual operating time generally not exceeding that of 50 hours, during which time the machine is primarily used to maintain small-scale, residential lawns and home/hobby gardens. Public facilities, sporting halls, and agricultural/forestry applications are excluded.

Please note that our equipment has not been designed for use in commercial, trade or industrial applications. Our warranty will be voided if the machine is used in commercial, trade or industrial businesses or for equivalent purposes.

The operating instructions as supplied by the manufacturer must be kept and referred to in order to ensure that the lawn mower is properly used and maintained. The instructions contain valuable information on operating, maintenance and servicing conditions.

Important! Due to the high risk of bodily injury to the user, the lawn mower may not be used to trim bushes, hedges or shrubs, to cut scaling vegetation, planted roofs, or balcony-grown grass, to clean (suck up) dirt and debris off walkways, or to chop up tree or hedge clippings. Moreover, the lawn mower may not be used as a power cultivator to level out high areas such as molehills.

For safety reasons, the lawn mower may not be used as a drive unit for other work tools or toolkits of any kind.

**CONTENTS**

SECTION 1 SYMBOLS MARKED ON THE PRODUCT.....	4
SECTION 2 GENERAL SAFETY RULES.....	4
SECTION 3 PARTS DESCRIPTION.....	7
SECTION 4 TECHNICAL DATA.....	8
SECTION 5 ASSEMBLY.....	8
SECTION 6 OPERATION INSTRUCTIONS .....	10
SECTION 7 MAINTENANCE INSTRUCTIONS.....	13
SECTION 8 LUBRICATION INSTRUCTIONS.....	13
SECTION 9 CLEANING.....	13
SECTION 10 STORAGE INSTRUCTIONS (OFF SEASON).....	14
SECTION 11 TROUBLESHOOTING.....	16
SECTION 12 WARRANTY.....	17
SECTION 13 ENVIRONMENT.....	17
SECTION 14 EC-DECLARATION OF CONFORMITY.....	18

## **!WARNING :**

For your own safety please read this manual before attempting to operate your new mower. Failure to follow instructions can result in serious personal injury. Spend a few moments to familiarise yourself with your mower before each use.

### 1. SYMBOLS MARKED ON THE PRODUCT



Fig. A

B.1 Read Operator's Manual.

B.2 Keep bystanders away.

B.3 Pay attention to the operator's hands and feet to avoid injury.

B.4 Fuel is flammable, keep fire away. Do not add fuel with running machine.

B.5 Toxic fumes; don't operate indoors, including your garage or shed.

B.6 When mowing, please wear protective glasses and ear plugs to defend the operator himself.

B.7 When repairing, please remove the spark plug, before undertaking repair work according to the operational manual.

B.8 Caution: Engine hot.



Figure B: Safety Label Found On Lawn Mower: KEEP HANDS AND FEET AWAY.

## **WARNING:**

Keep the safety signs clear and visible on the equipment. Replace the safety signs if they are missing or illegible.

### 2. GENERAL SAFETY RULES

**!WARNING:** When using petrol tools, basic safety precautions, including the following, should always be followed to reduce the risk of serious personal injury and/or damage to the unit. Read all these instructions before operating this product and retain these instructions for future reference.

**!WARNING:** This machine produces an electromagnetic field during operation. This field may under some circumstances interfere with active or passive medical implants. To reduce the risk of serious or fatal injury, we recommend persons with medical implants to consult their physician and the medical implant manufacturer before operating this machine.

### Training

1. Before using the lawnmower read the instructions carefully. Familiarise yourself with the controls and pay particular attention in learning how to stop the machine in an emergency.
2. Never allow children or people unfamiliar with these instructions to use the lawn mower. Local regulations can restrict the age of the operator.
3. Never mow while people, especially children or pets are nearby.
4. Never use the mower if the operator is taking medicine or substances that could affect or impair his ability to react or concentrate.
5. Keep in mind that the operator or user is responsible for accidents or hazards occurring to other people or their property.
6. The operators must receive proper training in the use, adjustment and operation of the machine, including prohibited operations.

### Before you start

1. While mowing, always wear substantial footwear and long trousers. Do not operate the equipment when barefoot or wearing open toed sandals.
2. Thoroughly inspect the area where the equipment is to be used and remove all objects, such as stones, toys, sticks and wires, which could be damaged or be thrown by the machine.
3. **WARNING-** Petrol is highly flammable.
  - Store fuel in containers specifically designed for this purpose.
  - Refuel outdoors only and do not smoke while refuelling; add fuel before starting the engine.
  - Never remove the cap of the fuel tank or add petrol while the engine is running or when the engine is hot.
  - If petrol is spilled, do not attempt to start the engine, but move the machine away from the area of spillage and avoid creating any source of ignition until petrol vapours have dissipated.
  - Replace all fuel tank and container caps securely.
4. Replace faulty silencers.
5. Before using, always visually inspect to see that the blade, blade bolts and cutter assembly are not worn or damaged. Replace worn or damaged blades and bolts in sets to preserve balance.

### Operation and Caution

1. Do not operate the engine in a confined space where dangerous carbon monoxide fumes can collect, refuel outdoors only.
2. Mow only in daylight or in good artificial light.
3. Avoid operating the equipment in wet grass, where feasible.
4. Always be sure of your footing on slopes.
5. Walk, never run, always be in control of the lawnmower and never allow yourself to be pulled along.
6. For wheeled rotary machines, mow across the face of slopes, never up and down.
7. Exercise extreme caution when changing direction on slopes.
8. Do not mow excessively steep slopes of more 20°
9. Use extreme caution when reversing or pulling the lawn mower towards you.
10. Stop the blade if the lawn mower has to be tilted for transportation when crossing surfaces other than grass, and when transporting the lawn mower to and from the area to be mowed
11. Never operate the lawn mower with defective guards, or without safety devices, for example

deflectors and/or grass catchers, in place.

12. Do not change the engine governor settings or over speed the engine.
  13. Before starting the engine disengage all blades and drive clutches.
  14. Keep your feet well away from the blade when starting the engine and in accordance with the instructions.
  15. Do not tilt the lawn mower when starting the engine and always start on a flat surface free from longgrass.
  16. Caution: The lawnmower shall not be operated without either the entire grass catcher or self-closing discharge opening guard in place.
  17. Do not start the engine when standing in front of the discharge chute.
  18. Never put hands or feet near or under rotating parts. Keep clear of the discharge opening at all times.
  19. Always ensure the engine is fully switched off before picking up/carrying the Lawnmower.
  20. Stop the engine and disconnect the spark plug wire, make sure that all moving parts have come to a complete stop and, where a key is fitted remove the key, make sure engine has had time to cool.
- Before unclogging chute and clearing blockages.
  - Before checking, cleaning or working on the lawn mower.
    - After striking a foreign object. Inspect the lawnmower for damage and make repairs before restarting.
  - If the lawn mower starts to vibrate abnormally (check immediately).
    21. Stop the engine and disconnect the spark plug wire, make sure that all moving parts have come to a complete stop and, where a key is fitted remove the key, make sure engine is completely cooled.
  - Whenever you leave the lawn mower.
  - Before refuelling.
    22. Reduce the throttle setting during engine shut down and, if the engine is provided with a shut-off valve, turn the fuel valve off at the conclusion of mowing.

#### Maintenance and Storage

1. Keep all nuts, bolts and screws tight to be sure the equipment is in safe working condition.
2. Never store the equipment with petrol in the tank inside a building where fuel vapours can reach an open flame or spark or where the temperature is high.
3. Before storage allow the engine to cool. When cooled, clean and undertake any maintenance.
4. To reduce the fire hazard, keep the engine, silencer, battery compartment and petrol storage area free of grass, leaves, or excessive grease.
5. Check the grass catcher and deflector frequently for wear or deterioration.
6. Replace worn or damaged parts for safety. Genuine parts should always be used as parts of inferior quality can damage the equipment and compromise safety.
7. If the fuel tank has to be drained, this should be done outdoors. Always ensure engine is completely cooled before starting this task.
8. If the blade needs to be removed, wear strong gloves to prevent injury to hands and fingers. Check the blades balance after sharpening.
9. When transporting the machine make sure you close the fuel cut off. Be careful to ensure weight is evenly distributed. Wear strong gloves.
10. When tilting the machine never tilt towards the air filter as this may become damaged with fuel.
11. Never crank the engine when the spark plug is removed.
12. Frequently check the fuel lines and fittings for damage and cracks, replace if necessary
13. Never start the engine with the air filter cover removed.
14. Carefully clean the mower and grass bag after use to remove debris as this can damage and corrode.

#### Fertilisers and top dressings are particularly corrosive.

15. In time your chassis may peel because of the abrasive action of the debris making contact. This can

be remedied by touching up paintwork where necessary to prevent corrosion.

16. Improper maintenance, use of non-conforming replacement components, or the removal or modification of safety components can damage the lawnmower and injure the operators seriously.
17. Only use the recommended blades and spare parts by the manufacturer. The use of non-genuine parts can damage the machine and injure the operators. Keep the lawnmower in good working condition.
18. If the blade stopping device doesn't work, please contact service centre for help.

**⚠ Warning: Do not touch rotating blade.**

**⚠ Warning: Refuel in a well ventilated area with the engine stopped.**

### 3. PARTS DESCRIPTION

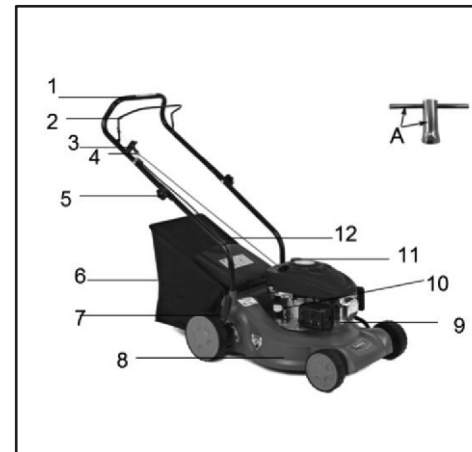

M41C

Fig.1

- |                           |                         |                   |
|---------------------------|-------------------------|-------------------|
| 1. Upper handle           | 2. Brake control handle | 3. Starter handle |
| 4. Rope Guide             | 5. Locking knob         | 6. Grass catcher  |
| 7. Height adjusting lever | 8. Deck                 | 9. Spark plug     |
| 10. Oil cap               | 11. Fuel cap            | 12. Cable clamp   |

#### Including

- A: Spark plug wrench

#### 4. TECHNICAL DATA

Model	M41C
Engine type	Cobra DG350
Self-Propelled	No
Engine Displacement	98.5 cm <sup>3</sup>
Blade Width	410mm
Nominal Power	1.9KW
Rated Speed	3000/min
Fuel Tank Capacity	0.8L
Grass catcher capacity	50L
Net Weight	19.6 kg
Height adjustment	25-75mm, 7 adjustment

	M41C
Guaranteed Sound pressure level at the operator's position (According to EN 836 Annex H & EN ISO 4871)	86,7 dB(A) (K=3dB(A))
Measured sound power level	91,73dB(A) K=0,85dB(A)
Guaranteed Sound Power level (According to 2000/14/EC)	96 dB(A)
Vibration (According to EN 836 Annex G)	5,786m/s <sup>2</sup> K=1,5 m/s <sup>2</sup>

#### 5. ASSEMBLY

##### 5.1 FOLDING HANDLE

1. Insert the lower handlebars into the fixed holes of the unit body, and then fixed with supplied screws with a screwdriver. ( Fig.2A/2B)
2. Release the upper handlebars for folding
3. Connect the upper handle and the lower handle with the locking knob. (Fig.2C)
4. Attach the cable-clamp to the position shown and then attach the cable. (Fig.2D)

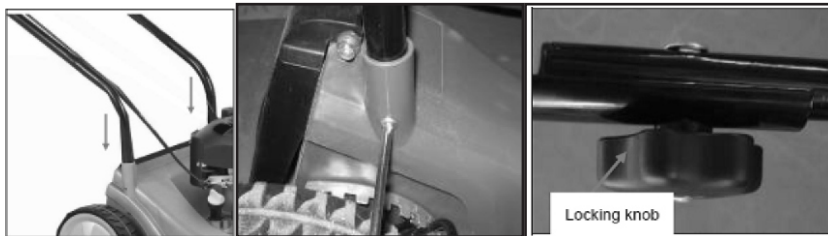

Fig.2A

Fig.2B

Fig.2C

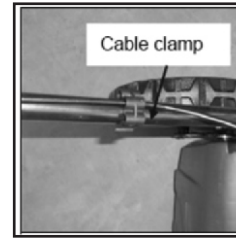

Fig.2D

##### 5.2 MOUNTING AND DISMOUNTING THE GRASS CATCHER

1. To fit: Raise the rear cover and hitch the grass catcher on rear of mower. (Fig.3A/3B)
2. To remove: grasp and lift rear cover, remove grass catcher.



Fig.3A

Fig.3B

##### 5.3 STARTER HANDLE

Move the starter handle from the engine to the rope guide.

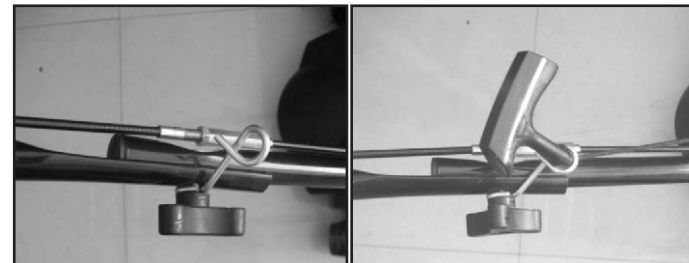

Fig.4A

Fig.4B

##### 5.4 HEIGHT OF CUT

Apply outward pressure to disengage lever from the rack. Move lever forward or back to adjust height. (Fig.5)



Fig.5

## 6. OPERATING INSTRUCTIONS

### 6.1 BEFORE STARTING

Service the engine with gasoline and oil as instructed in the separate engine manual packed in your mower. Always check and fill oil as necessary before starting. Read instructions carefully.

**! WARNING:** Petrol is highly flammable.

Store fuel in containers specifically designed for this purpose.

Refuel outdoors only, before starting the engine and do not smoke while refueling or handling fuel.

Never remove the cap of the fuel tank or add petrol while the engine is running or when the engine is hot.

If petrol is spilled, do not attempt to start the engine but move the machine away from the area of spillage and avoid creating any source of ignition until petrol vapors have dissipated.

Replace all fuel tanks and container caps securely.

Before tipping the lawn mower to maintain the blade or drain oil, remove fuel from the tank.

**! WARNING:** Never fill fuel tank indoors, with engine running or until the engine has been allowed to cool for at least 15 minutes after running.

### 6.2 TO START ENGINE AND ENGAGE BLADE

1. The unit is equipped with a rubber boot over the end of the spark plug, make certain the metal loop on the end of the spark plug wire (inside the rubber boot) is fastened securely over the metal tip on the spark plug.
2. When starting cool, press the primer bulb 3-5 times before starting the engine. (Fig.6A)
3. Standing behind the unit grasp the brake control handle and hold it against the upper handle as shown in Fig.6B.
4. Grasp the starter handle and pull up rapidly. Return it slowly to the rope guide bolt after engine starts. Fig.6B. Release the brake control handle to stop the engine and blade.

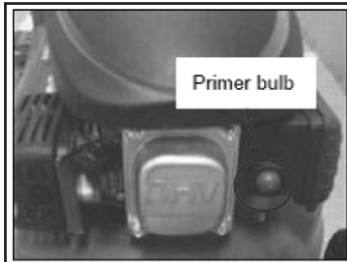

Fig.6A



Fig.6B

**! WARNING:** Start the engine carefully according to instructions and with feet well away from the blade.

**! WARNING:** Do not tilt the lawn mower when starting the engine. Start the mower on a level surface, free of high grass or obstacles.

**! WARNING:** Keep hands and feet away from the rotating parts. Do not start the engine when standing in front of the discharge opening.

### 6.3 OPERATION PROCEDURES

During operation, tightly hold the brake handle with both hands.

Note: During operation, when the brake handle is released, the engine will stop and thus stopping the lawnmower from operating.

**! WARNING:** In order to avoid any unintentional start-ups of the lawn mower, it comes equipped with an engine brake which must be pulled back before the engine can be started. When the engine control lever is released it must return to its initial position, at which point the engine automatically switches off.

Note: Engine brake (brake handle): Use the lever to stop the engine. When you release the lever the engine and the blade stop automatically. To mow, hold the lever in the working position. Before you start to mow, check the start/stop lever several times to be sure that it is working properly. Ensure that the tension cable can be smoothly operated (i.e. is not catching or kinking in any way)

### 6.4 TO STOP ENGINE

**! CAUTION:** The blade continues to rotate for a few seconds after the engine is shut off.

1. Release the brake control handle to stop the engine and blade.
2. Disconnect and ground the spark plug wire as instructed in the separate engine manual to prevent accidental starting while equipment is unattended.

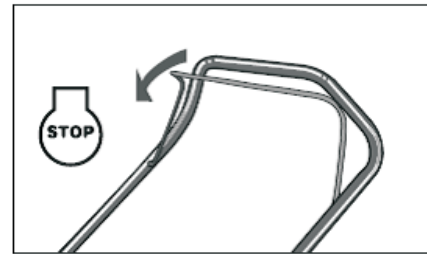

Fig.7

### 6.5 FOR THE BEST RESULTS WHEN MOWING

Clear lawn of debris. Be sure that the lawn is clear of stones, sticks, wire or other foreign objects which could be accidentally thrown out by the mower in any direction and cause serious personal injury to the operator and others as well as damage to property and surrounding objects.

Do not cut wet grass. For effective mowing do not cut wet grass because it tends to stick to the underside of the deck preventing proper mowing of the grass. Cut no more than 1/3 the length of the grass. The recommended cut for mowing is 1/3 the length of the grass. Ground speed will need to be adjusted so the clippings can be dispersed evenly into the lawn. For especially heavy cutting in thick grass it may be necessary to use one of the slowest speeds in order to get a clean well mowed cut. When mowing long grass you may have to cut the lawn in two passes, lowering the blade another 1/3 of the length for the second cut and perhaps cutting in a different pattern than was used the first time.

Overlapping the cut a little on each pass will also help to clean up any stray clippings left on the lawn. The mower should always be operated at full throttle to get the best cut and allow it to do the most effective job of mowing. Clean underside of the deck. Be certain to clean the underside of the cutting deck after each use to avoid a build-up of grass, which would prevent proper mulching.

Mowing leaves. The mowing of leaves can also be beneficial to your lawn. When mowing leaves make sure they are dry and are not laying too thick on the lawn. Do not wait for all the leaves to be off the trees before you mow.

**⚠ WARNING: If you strike a foreign object, stop the engine.** Remove wire from spark plug, thoroughly inspect the mower for any damage and repair the damage before restarting and operating the mower. Extensive vibration of the mower during operation is an indication of damage. The unit should be promptly inspected and repaired. If a large object has been struck during mowing this could cause terminal damage to your machine.

### 6.6 GRASS CATCHER

If the grass catcher is full of grass, you will need to empty and clean the grass catcher, make sure it is clean and ensure its meshwork is ventilated.

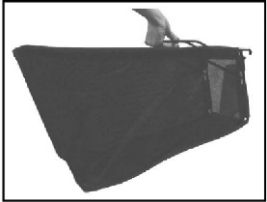

Fig.9A

### 6.7 DECK

The underside of the mower deck should be cleaned after each use to prevent a build-up of grass clippings, leaves, dirt or other matter. If this debris is allowed to accumulate, it will invite rust and corrosion of metal parts of the mower, and may prevent proper mulching. The deck may be cleaned by tilting the mower and scraping clean with a suitable tool (make certain the spark plug wire is disconnected) and never tilt towards the air filter as this can become damaged.

### 6.8 HEIGHT ADJUSTMENT INSTRUCTIONS

**⚠ CAUTION:** Do not at any time make any adjustment to lawnmower without first stopping the engine and disconnecting the spark plug wire.

**⚠ CAUTION:** Before changing mowing height, stop mower and disconnect spark plug cable.

Your mower is equipped with a central height adjustment lever offering 7 height positions. (Fig.9)

The height (the blade to the ground) can be adjusted from 25 mm to 75 mm (7 height positions).

1. Stop the mower and disconnect spark plug cable before changing mower cutting height.

2. The central height adjustment lever offers you 7 different height positions.

To change the height of cut, squeeze adjuster lever toward the wheel, moving up or down to selected height.

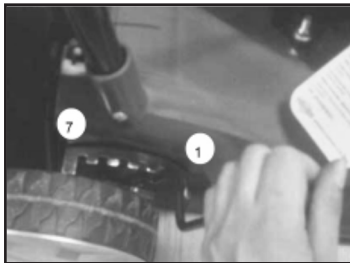

Fig.9

## 7. MAINTENANCE INSTRUCTIONS

### SPARK PLUG

Use only original replacement spark plug. For best results, replace the spark plug every 100 hours of use.

### ENGINE BRAKE PADS

As part of the dealer service check and replace the engine brake pads as necessary.

## 8. LUBRICATION INSTRUCTIONS

**⚠ CAUTION:** Disconnect the Spark Plug before servicing.

1. WHEELS-Lubricate the ball bearings in each wheel at least once a season with a light oil.
2. ENGINE-Follow engine manual for lubrication instructions.

### 9. CLEANING

**⚠ CAUTION:** Do not hose engine. Water can damage engine or contaminate the fuel system.

1. Wipe deck with dry cloth.
2. Hose under deck by tilting the mower so that the spark plug is up.

### 9.1 ENGINE AIR CLEANER

**⚠ CAUTION:** Do not allow dirt or dust to clog the air filter foam element.

The engine air cleaner element must be serviced (cleaned) after 25 hours of normal mowing. The foam element must be serviced regularly if the mower is used in dry dusty conditions.

#### To CLEAN AIR FILTER

1. Remove screw.
2. Press down the two tabs on top of the filter cover. Remove cover.
3. Wash filter element in soap water. **DO NOT USE PETROL!**
4. Air dry filter element.
5. Place a few drops of SAE30 oil on the foam filter and squeeze tightly to remove any excess oil.
6. Reinstall filter.

**⚠ NOTE:** Replace filter if frayed, torn, damaged or unable to be cleaned.

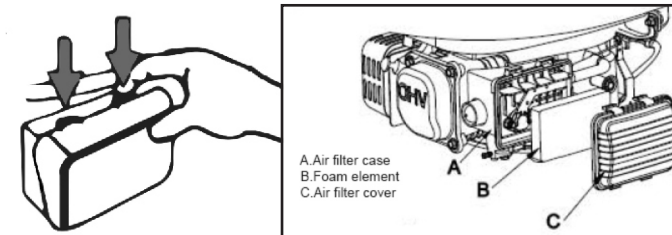

Fig.11A

Fig.11B

### 9.2 CUTTING BLADE

**⚠ CAUTION:** Be sure to disconnect and ground the spark plug wire before working on the cutting blade to prevent accidental engine starting. Protect hands by using heavy gloves or a rag to grasp the cutting blades. Tip mower as specified in separate engine manual. Remove the hex bolt and washer which hold the blade and blade adapter to the engine crankshaft. Remove the blade and adapter from the crankshaft.

**! WARNING:** Periodically inspect the blade adapter for cracks, especially if you strike a foreign object, replace when necessary.

For best results your blade should be sharp. The blade may be re-sharpened by removing it and either grinding or filing the cutting edge keeping as close to the original bevel as possible. It is extremely important that each cutting edge receives an equal amount of grinding to prevent an unbalanced blade. Improper blade balance will result in excessive vibration causing eventual damage to the engine and mower. Be sure to carefully balance blade after sharpening. The blade can be tested for balance by balancing it on a round shaft screwdriver. Remove metal from the heavier side until it balances evenly.

Before reassembling the blade and the blade adapter to the unit, lubricate the engine crankshaft and the inner surface of the blade adapter with light oil. Install the blade adapter on the crankshaft. Refer to figure 12. Place the blade with the part number facing away from the adapter. Align the washer over the blade and insert the hex bolt. Tighten the hex bolt to the torque listed below:

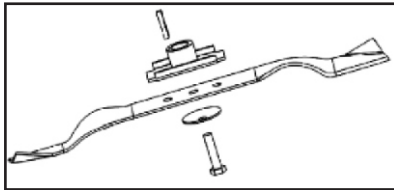

Fig.12

### 9.3 BLADE MOUNTING TORQUE

Center Bolt 40Nm.min, 54Nm.max. To insure safe operation of your unit. ALL nuts and bolts must be checked periodically for correct tightness. After prolonged use, especially in sandy soil conditions, the blade will become worn and lose some of the original shape. Cutting efficiently will be reduced and the blade should be replaced. Replace with an approved factory replacement blade only. Possible damage resulting from blade unbalance condition is not the responsibility of the manufacturer.

When you change the blade, you must use the original type marked on the blade. Contact your local Cobra dealer for details.

**! WARNING:** Do not touch rotating blade.

### 9.4 ENGINE

Refer to the separate engine manual for engine maintenance instructions.

Maintain engine oil as instructed in the separate engine manual packed with your unit.

Read and follow instructions carefully.

Service air cleaner as per separate engine manual under normal conditions. Clean every few hours under extremely dusty conditions. Poor engine performance and flooding usually indicates that the air cleaner should be serviced.

To service the air cleaner, refer to the separate engine manual packed with your unit.

The spark plug should be cleaned and the gap reset once a season. Spark plug replacement is recommended at the start of each mowing season; check engine manual for correct plug type and gap specifications.

Clean the engine regularly with a cloth or brush. Keep the cooling system (blower housing area) clean to permit proper air circulation which is essential to engine performance and life. Be certain to remove all grass, dirt and combustible debris from the muffler area.

## 10. STORAGE INSTRUCTIONS (OFF SEASON)

The following steps should be taken to prepare lawn mower for storage.

1. Empty the tank after the last mowing of the season.

a) Empty the petrol tank with a suction pump.

**! CAUTION!** Do not drain the petrol in closed rooms, in close proximity of open fire, etc. Do not smoke!

Petrol fumes can cause explosion or fire.

b) Start the engine and let it run until it has used up all remaining petrol and stalls.

c) Remove the spark plug. Use an oilcan to fill approx. 20 ml oil into the combustion chamber. Operate the starter to evenly distribute the oil in the combustion chamber. Replace the spark plug.

2. Clean and grease the lawnmower carefully as described above under "Lubrication".

3. Slightly grease the cutter to avoid corrosion.

4. Store the lawnmower in a dry, clean and frost-protected place, out of reach of unauthorised persons.

**! CAUTION!** The engine must have completely cooled down before storing the lawnmower.

**! NOTE:** - When storing any type of power equipment in an unventilated or material storage shed,

-Care should be taken to rust-proof the equipment. Using a light oil or silicone, coat the equipment, especially cables and all moving parts.

- Be careful not to bend or kink cables.

- If the starter rope becomes disconnected from rope guide on the handle, disconnect and ground the spark plug wire, Depress the blade control handle and pull the starter rope out from engine slowly. Slip the starter rope into the rope guide bolt on the handle.

### Transport

Turn the engine off and allow the engine to cool down. Then disconnect the spark plug wire and empty the fuel tank according to the instructions in the engine manual. Ensure not to bend or damage the cutter when pushing the lawnmower over obstacles.



## 11. TROUBLESHOOTING

PROBLEM	PROBABLE CAUSE	CORRECTIVE ACTION
Engine does not start.	Throttle choke not in the correct position for the prevailing conditions.	Move throttle chock to correct position
	Fuel tank is empty.	Fill tank with fuel: refer to ENGINE OWNERS MANUAL.
	Air cleaner element is dirty.	Clean air cleaner element: refer to ENGINE OWNERS MANUAL
	Spark plug loose.	Tighten spark plug to 25-30Nm.
	Spark plug wire loose or Disconnected from plug.	Install spark plug wire on spark plug.
	Spark plug gap is incorrect.	Set gap between electrodes at 0.7 to 0.8mm
	Spark plug is defective	Install new, correctly gapped plug: refer to ENGINE OWNERS MANUAL
	Carburettor is flooded with fuel	Remove air cleaner element and pull starter rope continuously until carburettor clears itself and install air cleaner element.
	Faulty ignition module	Contact the service agent.
Engine difficult to start or loses power.	Dirt, water, or stale fuel tank.	Drain fuel and clean tank. Fill tank with clean, fresh fuel
	Vent hole in fuel tank cap is plugged.	Clean or replace fuel tank cap.
	Air cleaner element is dirty.	Clean air cleaner element.
Engine operates erratically.	Spark plug is defective.	Install new, correctly gapped plug: refer to ENGINE OWNERS MANUAL
	Spark plug gap is incorrect.	Set gap between electrodes at 0.7 to 0.8mm
	Air cleaner element is dirty.	Clean air cleaner element: refer to ENGINE OWNERS MANUAL
Engine idles poorly.	Air cleaner element is dirty.	Clean air cleaner element: refer to ENGINE OWNERS MANUAL
	Air slots in engine shroud are blocked.	Remove debris from slots.
	Cooling fins and air passages under engine blower housing are blocked.	Remove debris from cooling fins and air passages.
Engine skips at high speed.	Gap between electrodes of spark plug is too close.	Set gap between electrodes at 0.7 to 0.8mm
Engine overheats	Cooling air flow is restricted.	Remove any debris from slots in shroud, blower housing, air passages
	Incorrect spark plug.	Install F7RTC spark plug and cooling fins on engine.
Mower vibrates abnormally	Cutting assembly is loose.	Tighten blade
	Cutting assembly is unbalanced	Balance blade.

## 12. WARRANTY

This product is warranted in accordance with legal regulations for a 24 month period effective from the date of purchase by the first user.

This product will not be covered if used in a commercial application.

This warranty covers all material or production failures, it does not include: defects from normal wear and tear, parts such as, bearings, brushes, cables, air cleaning elements, brake pad, clutch disc, tyre, wheel, recoil starter rope, belts, cutter blades, plugs, lubricant oils and grease or accessories. Damage or defects resulting from abuse, accidents or alterations, natural fading of painted or plated surfaces, sheet peeling and other natural deterioration.

Any damage that occurs from the use of non-genuine Cobra parts will not be covered.

We reserve the right to reject any claim where the purchase cannot be verified or when it is clear that the product was not maintained properly. (Clean ventilation slots, carbon brushes and serviced regularly)

Expenses incidental to the warranty claim that are not covered;

-Compensation for loss of time, commercial loss or rental costs of substitute product.

-Costs incurred for transportation to and from the dealership.

Any damage that occurs from the following will not be covered; exposure of the product to smoke and soot, chemical agents, bird droppings or other animal waste, seawater, sea breeze, salt or other environmental phenomena.

Any damage resulting from operating methods other than those indicated in the owner's manual will not be covered.

Your purchase receipt must be kept as proof for date of purchase. Your un-dismantled mower must be returned to your dealer in an acceptably clean state, accompanied by your proof of purchase.

### Please Register Your Mower

If your dealer did not collect registration information from you, please take a few minutes and register your purchase with Cobra.

You can register by completing and mailing the registration card that should be in the box or by going online to [www.cobragarden.co.uk](http://www.cobragarden.co.uk) and clicking on Product Registration.

Before using the lawn mower, all mower operators must read this manual

## 13. ENVIRONMENT

Should your machine need replacement after extended use, do not put it in the domestic waste but dispose of it in an environmentally safe way.



#### 14. EC DECLARATION OF CONFORMITY

We herewith declare,	Cobra Garden Machinery Henton & Chattell Ltd, London Road, Nottingham NG2 3HW United Kingdom
that the following machine complies with the appropriate basic safety and health requirements of the EC Directive based on its design and type, as brought into circulation by us.	
In case of alteration of the machine, not agreed upon by us, this declaration will lose its validity	
Machine Description:	Lawn Mower
Machine Type:	M41C (DYM1651PF)
Displacement:	98.5cm <sup>3</sup>
Cutting width:	410mm
Measured sound power level	91.73dB(A)
Guaranteed sound power level:	96dB(A) Notified Body for EC Directive 2000/14/EC:0499 TÜV Rheinland LGA Products GmbH Tillystrasse 2, 90431 Nürnberg, Germany 0197
Applicable EC Directives:	2006/42/EC 2014/30/EU 2000/14/EC
Applicable Harmonized Standards:	EN ISO 5395-1 EN ISO 5395-2 EN ISO 14982
Authorized Signature/Date/ Place:	 Peter J. Chaloner 02-10-2018
Title of Signatory:	Managing Director
Name and address of the person authorized to compile the technical file	Cobra Garden Machinery Henton & Chattell Ltd, London Road, Nottingham NG2 3HW United Kingdom